



*HANDI™*+ Oxygen Analyzer  
For verifying nitrox / air cylinders

# Operating Manual

**MANUAL Part # R218M16 Rev. B**  
***HANDI™*+ Part # R218P16**

---

**Maxtec, Inc.**

6526 South Cottonwood Street

Salt Lake City, Utah 84107

Tele: (801) 266-5300 FAX: (801) 270-5590

Toll Free in the U.S.: (800) 748-5355

[www.maxtecinc.com](http://www.maxtecinc.com)

# Index

Warranty Policy .....	Page 2
General Specifications .....	Page 3
Introduction .....	Page 4
Intended Use .....	Page 4
For Your Safety .....	Page 4
Operation .....	Page 6
General .....	Page 6
Low Pressure Port .....	Page 6
High Pressure Port .....	Page 7
Atmospheric Pressure .....	Page 7
Oxyknob .....	Page 8
Calibration .....	Page 9
Calibration Errors and Codes .....	Page 10
Maintenance and Disposal .....	Page 11
Ordering Information .....	Page 12

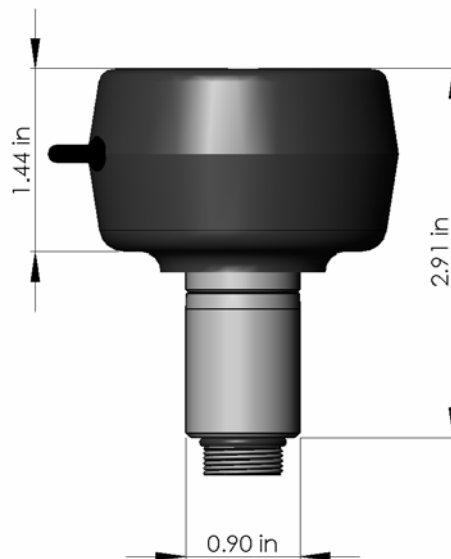

## **Warranty Policy**

*Maxtec<sup>®</sup> warrants to the original purchaser, that the HANDI<sup>TM</sup>+ analyzer to be free from defects in material and workmanship for a period of two-(2) years from the date of shipment from Maxtec<sup>®</sup> or from one of Maxtec<sup>®</sup>'s authorized dealers. Parts found to be defective as determined by Maxtec<sup>®</sup>, will be repaired or replaced free of charge if shipped prepaid to the factory in the original shipping carton. This warranty is void if the product has been subject to misuse or abuse, including but not limited to: exposure to water, humidity- temperature- shock or pressure outside of the listed specifications, or has not been operated in accordance with instructions, or if the identifying markings on the product label have been altered or removed. Routine maintenance items are excluded from this warranty.*

*The seller assumes no liability for consequential damages of any kind, and the buyer, by acceptance through purchase of this product, will assume all liability for the consequences of its use or misuse by the buyer, his employees, or others.*

*It is the sole responsibility of the buyer / user to determine if this product is suitable for the intended application.*

## General Specifications

<b>Sensor Type:</b>	Maxtec® MAX-250 galvanic cell w/ Temperature Compensation (Non-Replaceable)
<b>Sensor Type:</b>	Extra-Life Oxygen Sensor, galvanic cell type.
<b>Measurement Range:</b>	0.0 – 100.0% oxygen (gas).
<b>Resolution/ Display:</b>	0.1% - The three digit LCD indicates values between 0.0 – 99.9% oxygen.
<b>Display:</b>	The three digit LCD indicates values between 0.0 – 99.9% oxygen.
<b>Response Time:</b>	< 15 seconds for 90% step change. (at 23°C)
<b>Accuracy: @ 15° to 40°C</b>	± 1 % of full scale at constant temperature, R.H. and pressure when calibrated at full scale. ± 3% actual oxygen level over full operating temperature.
<b>Power:</b>	Powered by one internal, non-replaceable, lithium battery, CR2450. Power on push button automatically shuts off after 80 seconds time-out. Electronics rated general purpose; not for use in hazardous areas or for use with flammable gases.
<b>Battery Life:</b>	Approx. 1850 hours (74,000 cycles).
<b>Sample Port</b>	M-16 x 1 thread with barbed tubing adapter.
<b>Operating Temperature:</b>	15° to 40°C
<b>Storage Temperature:</b>	-15° to 50°C
<b>Expected Storage Life:</b>	Two months. Special freshness seal on sensor.
<b>Operating Pressure:</b>	Atmospheric pressure to 3psig.
<b>Environmental:</b>	General purpose housing equivalent to NEMA 1. The <i>HANDI™</i> + is not waterproof. 0 - 95% RH, non-condensing.
<b>Warranty:</b>	Twenty-four months in normal operating conditions.
<b>Weight:</b>	Approx. 60 grams

## Introduction

**Intended Use:** In diving applications, different blends of oxygen may be used for breathing. Varying the concentration of oxygen in the breathing gas may be used to extend “bottom time”, extend no-decompression time limits. Or reduce the amount of time required for decompression. For safety reasons it is very important not to confuse a cylinder of air with a cylinder of enriched oxygen. Mistaking compressed air for nitrox could lead to hazards such as nitrogen narcosis or decompression sickness.

The *HANDI™+* analyzer is a tool, which is well suited for identifying gas concentrations: air Vs 32% nitrox, 32% Vs 36% oxygen,... for example.

The *HANDI™+* is a convenient travel partner. It can be used to quickly identify the contents of cylinder gas obtained from unknown suppliers. The *HANDI™+* allows the diver to sort out cylinders, which may not have labels, or simply to verify those cylinders, which may be incorrectly labeled.

### **WARNING! For Your Safety:**

- The *HANDI™+* is not rated intrinsically safe nor is it designed for use in areas where flammable vapors are present.
- This device does not contain automatic barometric pressure compensation.
- Do not use near any type of flame or flammable/explosive substances, vapors or atmosphere.
- **The *HANDI™+* is a verification tool and should not be used to control the gas blending or process control applications.**

## ***Introduction continued***

### **CAUTION! For Your Safety:**

- Read the manual in its entirety before attempting use.
- Always use protective eyewear and observe proper safety procedures when working with pressurized gases.
- Always assure the pressure of gas entering the *HANDI™+* is 3psig or less.
- Always calibrate the *HANDI™+* at an equivalent pressure and flow rate to the measured gas.
- Always calibrate the *HANDI™+* whenever the point of use elevation changes more than 500 feet (i.e.: Mexico City vs. San Diego,...).
- Dispose of the *HANDI™+* properly when it has expired.
- Ensure the protective freshness seal has been removed from the sensing port before use.
- Ensure the *HANDI™+* has been properly calibrated before use.
- If the *HANDI™+* display goes blank immediately after the on button is pushed, or the *HANDI™+* will not properly calibrate, the unit has expired. Do not use, dispose of properly.
- The display is not valid when in Over Range Mode. Recalibrate the *HANDI™+* and observe the proper operating procedure.
- Never immerse the *HANDI™+* or expose it to high humidity or moisture. It is not watertight.
- Never expose the *HANDI™+* to flame or high temperatures.
- Never expose the *HANDI™+* directly to unregulated gas lines, cylinder gas, ... These may contain high gas pressures which may cause the *HANDI™+* to rupture.
- There are no internal user-serviceable parts in the *HANDI™+*.

## Operation

**General:** The plastic freshness seal on the sensing port should be removed and discarded when you are ready to use the *HANDI™+* for the first time. This seal ensured freshness of the *HANDI™+* during shipping and storage. Once the seal is removed, you should expect to obtain the normal life from the *HANDI™+*. Included in the kit you will find the barbed adapter, which will screw onto the sensing port.

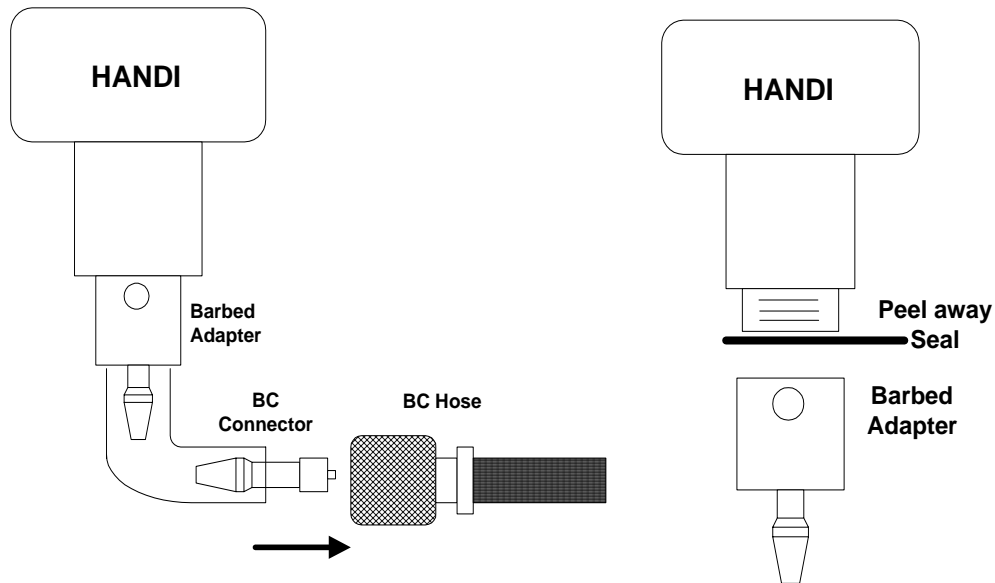

**Low Pressure Port:** The *HANDI™+* may be used to check the gas concentration directly at the hose leading to the Buoyancy Compensator (BC). The connection to the BC is normally through a quick connect type fitting. The hose fitting leading to the BC from the cylinder is a female quick connect. The BC has the male counterpart. Basically, a tube connection will be made from the hose to the *HANDI™+*.

The *HANDI™+* has a male barbed fitting, which will adapt to a piece of 1/4" soft plastic tubing. It is recommended to use the Maxtec standard BC fitting for the connection from the *HANDI™+* to the BC hose. Allow some gas to pass through the barbed adapter and then observe the concentration of oxygen displayed.

## Operation continued

**High Pressure:** The *HANDI™+* should never be connected to pressures greater than 3 psig. This could cause major failure of the sensing mechanism and may also cause the *HANDI™+* housing to rupture. The pressure must always be regulated down to the working pressure of the *HANDI™+* (0-3 psig). If you wish to measure the pressure directly at the cylinder, a suitable pressure regulator is required. The regulator must bring the gas entering the *HANDI™+* to 0-3 psig.

The *HANDI™+* has a male barbed fitting, which will adapt to a piece of 1/4" soft plastic tubing. The tubing can then be connected to the regulated pressure source. Allow some gas to pass through the barbed adapter and then observe the concentration of oxygen.

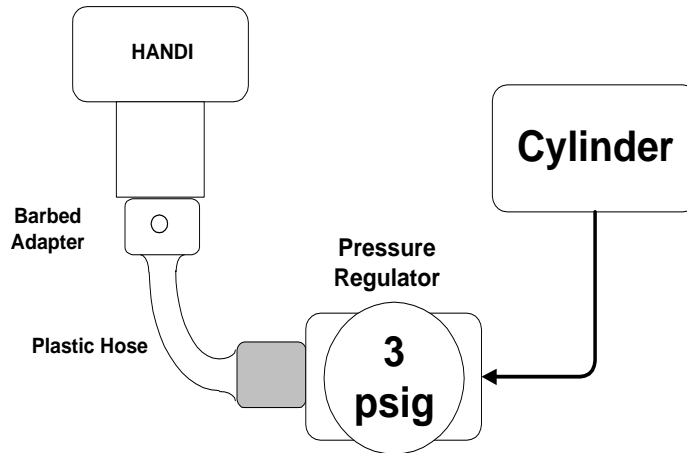

**Atmospheric Pressure:** In cases where it may be impractical to connect the *HANDI™+* directly to a regulated gas source, it is possible to take rough measurements at atmospheric pressure. For this application, unscrew the Barbed Adapter from the sensing port. Hold the *HANDI™+* up to the gas source (such as gas flowing from the cylinder to ambient air) and observe the oxygen concentration on the display. This method is not the most accurate but may be improved by capturing the sample gas within a small plastic bag in which the *HANDI™+* is also located. Inflate the bag and take the reading. For this application, calibrate on ambient air.



## ***Operation continued***

### **Oxyknob Instructions for Use:**

1. Attach the Oxyknob adapter to the threaded sensor of your Maxtec analyzer.
2. Hand tighten until sensor o-ring seals against the Oxyknob.
3. Slowly crack open the tank. Listen for a slight hissing sound.
4. Hold the Oxyknob up to the outlet of the tank.
5. Align the small hole in the bottom or side of the Oxyknob to the hole in the outlet of the tank.
6. Hold the analyzer in place until the reading has stabilized on the analyzer display.
7. Remove the Oxyknob after reading and close valve on the tank.

**WARNING:** High gas pressures may cause damage to oxygen sensor and result in incorrect readings. Turn down the tank valve as much as possible to avoid sensor damage. Do not cover the larger holes on the Oxyknob.

**WARNING:** Cold gas exiting a pressurized tank can cause the sensor reading to drift if exposed for an extended period of time. Allow sensor to warm between readings if necessary.

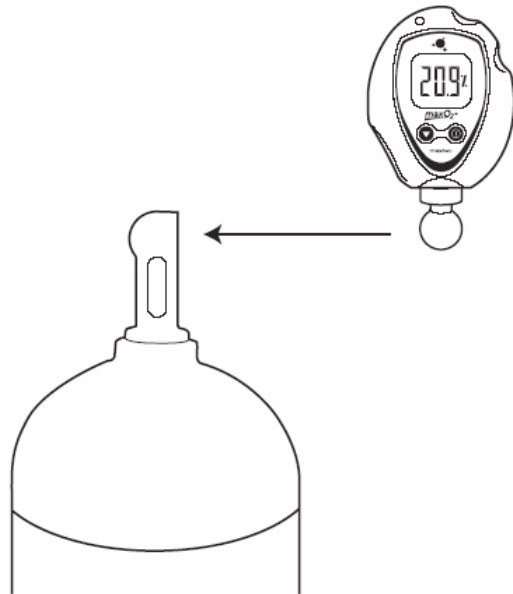

## Calibration

To simplify operation the Handi™+ Analyzer automatically determines the calibration gas being used as compressed air (20.9%) or high grade (100%).

For best performance and accuracy, the *HANDI™+* should be calibrated on a frequent basis. It is preferable to calibrate each day it will be used or at least once a month on a known source of oxygen. Clean, dry compressed air is a suitable cal gas.

Compressed air should be easy to obtain and may be used as the calibration gas source. Normal clean dry air contains approximately 20.9% oxygen. Expose the *HANDI™+* to compressed air and push the “CAL” button. The display will indicate the concentration of oxygen of the Calibration gas. It is recommended that the *HANDI™+* be calibrated on compressed air at a pressure and flow-rate equivalent to the measured nitrox or gas blend. This may be accomplished by using the same gas sampling apparatus for calibration as for measuring. For example, if the *HANDI™+* is used with the low-pressure adapter when checking cylinders, use the same setup when calibrating (except use a cylinder filled with compressed air rather than the nitrox mix). After the display reads 20.9%, the *HANDI™+* is now calibrated and may be used to verify oxygen concentrations.

Always recalibrate the *HANDI™+* if the point of use elevation has changed by 500 feet. If the *HANDI™+* does not calibrate correctly to 20.9% or 100.0% Oxygen, the oxygen sensor has probably expired. Replace the sensor.

# Calibration Errors and Error Codes

The **HANDI™+** analyzers have a self test feature built into the software to detect faulty calibrations, oxygen sensor failures, and low operating voltage. These are listed below, and include possible actions to take, if an error code occurs.

## **E02: No sensor attached**

Open unit and disconnect and reconnect sensor. Unit should perform an auto calibration and should read 20.9%. If not, contact Customer Service for possible sensor replacement.

## **E03: No valid calibration data available**

Make sure unit has reached thermal equilibrium. Press and hold the Calibration Button for three seconds to manually force a new calibration.

## **E04: Battery below minimum operating voltage**

Contact Customer Service for possible battery replacement.

## **CAL Err St: O2 Sensor reading not stable**

Wait for displayed oxygen reading to stabilize, when calibrating the device at 100% oxygen.

Wait for unit to reach thermal equilibrium (Please note that this can take up to one half hour, if the device is stored in temperatures outside the specified operating temperature range).

## **CAL Err lo: Sensor voltage too low**

Press and hold the Calibration Button for three seconds to manually force a new calibration. If unit repeats this error more than three times, contact Customer Service for possible sensor replacement.

## **CAL Err hi: Sensor voltage too high**

Press and hold the Calibration Button for three seconds to manually force a new calibration. If unit repeats this error more than three times, contact Customer Service for possible sensor replacement.

## **CAL Err Bat: Battery voltage too low to recalibrate**

Contact Customer Service for possible battery replacement.

## ***Maintenance and Disposal***

The *HANDI™+* analyzer requires little maintenance. For best performance and accuracy, the *HANDI™+* should be calibrated on a frequent basis. For general use, it is recommended the *HANDI™+* be calibrated once a month on a known source of oxygen such as clean dry (compressed) air. Reference the calibration section in this manual for more details.

If the unit becomes wet, it should be dried off immediately with a soft dry towel. The display may indicate low concentrations of oxygen if the sample port of the sensor becomes wet. In this case, remove the barbed adapter and thoroughly dry inside and out with a soft dry towel or cotton applicator tip. Additionally, dry the face of the sensor with a cotton applicator tip and allow to air dry for one half-hour (or until the oxygen display returns to normal). Exposure of the *HANDI™+* to water or extremely high RH may result in shortened life or cause the electronic circuit or battery to fail.

***Disposal:*** Please note the materials of construction for proper disposal. The material of the *HANDI™+* housing is a polycarbonate and ABS blend. The sensing portion of the *HANDI™+* contains lead and acetic acid. The *HANDI™+* contains a printed circuit board and a Lithium Battery.



**WARNING:** The *HANDI™+* should be disposed of properly in accordance with local regulations. Do not incinerate or expose the *HANDI™+* to flame or high temperatures.

# Ordering Information

<b>Description</b>	<b>Part Number</b>
SCUBA <i>HANDI</i> <sup>TM</sup> + .....	R218P16
Barbed Adapter .....	R207P17
Manual .....	R218M16
Clear Tube .....	R100P92-002
Lanyard .....	R213P92
MaxBox "Otter" .....	R213P90
Handi <sup>TM</sup> + Cover .....	R218P09
OxyKnob .....	R218P19

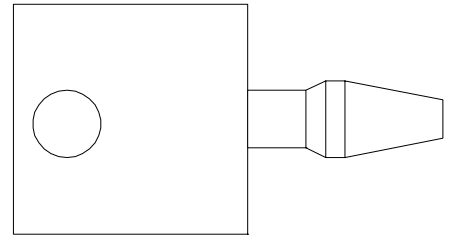

## Accessories:

Flow Diverter Fitting  
(for use with medical tee):  
#R110P10

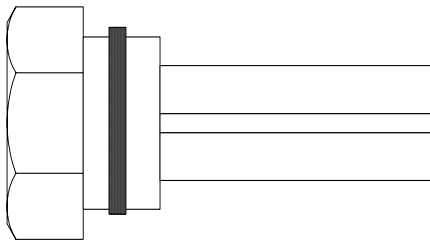

Standard BC Adaptor: #RP11P28

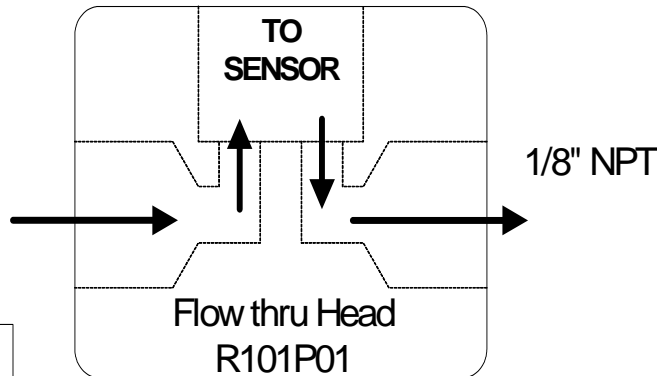
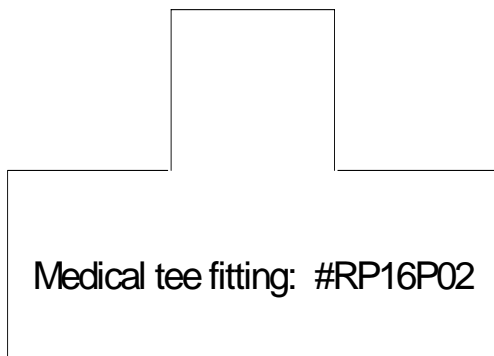
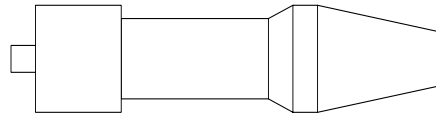

- *Sensors*
- *Monitors*
- *Analyzers*



*“Experts in Oxygen Analysis”*  
6526 South Cottonwood Street  
Salt Lake City, Utah 84107  
Tele: (801) 266-5300 FAX: (801) 270-5590  
Toll Free in the U.S.: (800) 748-5355

visit us at  
[www.maxtecinc.com](http://www.maxtecinc.com)